

REV LTR	DESCRIPTION	DATE	APPVD.
-	Orig. Release	6/22/09	RBT
A	Corrected P/N on Pages 1 and 2	5/08/14	RBT
B	Revised per ECN 2015-1	9/12/15	RBT
C	Revised per ECN 2016-1	9/18/16	RBT

FT1 Series
HCMOS/TTL OSCILLATORS
FOR SPACE APPLICATIONS
0.5MHz to 165 MHz
(5 x 7 mm, SMD, 1.8 V)

(Refer to Page 5 for Models with Reduced Screening & QCI)

1. SCOPE: FT1 series , HCMOS/TTL series, high reliability hybrid microcircuit crystal oscillators are designed, produced and tested by Frequency Technology, Inc. as MIL-PRF-55310, Class "S" equivalent devices for use in advanced military, avionics and space applications. These devices are of hybrid microcircuit technology conforming to MIL-PRF-55310, Type 1, Class 2 oscillators.

2. APPLICABLE DOCUMENTS:

MIL-PRF-55310E	Oscillator, Crystal Controlled, General Specifications for
MIL-PRF-38534G	Hybrid Microcircuits, General Specifications for
MIL-STD-883E	Test Methods and Procedures for Microelectronics

3. REQUIREMENTS:

3.1 General: The individual item requirements shall be as specified herein.

3.2 Package: Ceramic, 90% Min. AL_2O_3 . Thermal Resistance, θ_{JC} : 50 °C / Watt.

3.2.1 Termination Finish: 1.3 μm minimum gold plate over 2.0 μm minimum nickel plate. Hot Solder tinning with Sn60/Pb40 solder per MIL-PRF-55310 is optional at an additional cost.

3.2.2 Weight: 0.30 Gms Max.

3.2.3 Reflow Soldering: Reflow soldering at 260 °C for 10 seconds shall not degrade the performance.

3.3 Hermeticity: Resistance welded, hermetically sealed, leak rate of $1(10)^{-8}$ atm-cc/s Max.

3.4. Marking: As a minimum, the parts shall be marked with Fre-techP/N and date code

3.5 Absolute Maximum Ratings: Unless otherwise specified, absolute maximum ratings shall be as follows:

Supply Voltage	-0.5 to +3.0 VDC
Operating Free-Air Temperature Range	-55°C to +125°C
Storage Temperature	-65°C to +125°C

3.6 Electrical Characteristics: See Table I

3.6.1 Total Dose Radiation: Hybrid Microcircuit Crystal Oscillators shall be capable of meeting the electrical characteristics of Para. 3.6 after being exposed to total ionizing dose radiation of 100 krads as per MIL-STD-883, method 1019.

3.7 Hybrid Elements:

3.7.1 Quartz Crystals: High grade cultured quartz crystal shall be used. As an option, Fre-tech will use premium Q swept quartz crystal at an additional charge, refer to part numbering example in paragraph 6 to specify swept quartz crystal. Crystal element evaluation shall be in accordance with MIL-PRF-55310.

3.7.2 Crystal Mounting: Crystal element shall be mounted at 4 points in such a manner as to provide adequate ruggedness and performance under extreme environments specified herein.

- 3.7.3 Passive Elements: Established Reliability (ER) QPL components, failure level R minimum shall be used or element lot evaluation shall be as per MIL-PRF-55310, class S, or MIL-PRF-38534, Appendix C, Class K as applicable.
- 3.7.4 Microcircuit die shall be from lots that have passed the element evaluation per MIL-PRF-55310, Appendix B, Level S, except testing per Subgroup 5 is omitted. Subgroup 5 testing is circuit configuration dependent, therefore, it is more effectively performed at the oscillator level as explained in Paragraph 3.7.4 herein.
- 3.7.5 For Output Frequency up to 90 MHz, microcircuit die used in the oscillator shall be from NSC/FC 54ACT family and must be from wafer lot that has been successfully tested in the oscillator for ionizing radiation of up to 100 krad. Fre-tech has also performed SET & SEL testing on the microcircuit die. Test reports are available on request. For output frequencies above 90 MHz, the microcircuit die shall be from 0,8 μm BiCMOS Si family and must be from wafer lots that have been successfully tested in the oscillator for ionizing radiation of up to 100Krad and is known to be Single Event Latch-up immune for LET of up to 95 Mev-cm²/mg.
- 3.7.6 Workmanship, Rework and Process controls shall be in accordance with the requirements of MIL-PRF-55310.
- 3.7.7 Lot Traceability: Production lot for these oscillators shall be homogenous. Each element used in the production lot shall be traceable to a single lot. Swept quartz shall be traceable to the quartz bar, and its applicable processing details.
4. Quality Assurance Provisions: The quality assurance provisions shall be per MIL-PRF-55310, except as specified herein.
- 4.1 100% Screening: The 100% screening shall be performed as per Table II. PDA requirements for nondestructive bond pull and burn-in shall be as specified below.
- 4.2 PDA for Nondestruct Bond Pull: Unless otherwise specified, PDA shall be 2% of total number of wires or 1 wire whichever is greater.
- 4.3 PDA for Burn-in: Unless otherwise specified, PDA for burn-in shall be 2% or 1 oscillator whichever is greater and shall be applicable to +23 °C and/or +25 °C static tests only. In addition Delta Calculation shall be performed after Burn-in and shall count for PDA. All measured values for Delta Calculation shall be recorded. Parts that exceed the specified delta limits shall be rejected and be counted for PDA. Delta Calculation shall be performed at 3.3 VDC for the following parameters:
- | | |
|-------------------|---------------------|
| Input Current | 10% change Maximum |
| Output High Level | 10% change Maximum |
| Output Low Level | 0.1V change Maximum |
- 4.4 Group A inspection shall be in accordance with MIL-PRF-55310 for product level S.
- 4.5 Group B inspection (30 day aging) shall be in accordance with MIL-PRF-55310 for product level S. In order to expedite delivery, by customer request, the aging test can be ended after 15 days if the amount of frequency aging is less than 50% of the 30 day specification limit.
- 4.6 Oscillators shall be capable of meeting group C inspection per MIL-PRF-55310. Generic group C inspection data on similar parts may be used to satisfy this requirement. When specified by the Customer, Fre-tech will perform Group C testing at an additional charge.

4.7 Inspection and Test Data: Unless otherwise specified in the purchase order, the following Inspection and test data documentation shall be supplied with the parts.

Certificate of Conformance
Summary of Class "S" screening Test Results
PDA Calculations for Non-Destruct Bond Pull and Burn-in
Summary of Elements Lot Traceability
Electrical Tests before and after Burn-in
Group A Inspection Summary
Group B (30 day Aging) Data
Radiographic Inspection Certificate

4.8 The following test and inspection options are available at customer request.

Customer Source Inspection for Pre-Cap and Final
Group C Inspection per MIL-PRF-55310 on 4 or 8 units
DPA (Destructive Physical Analysis)
Life Test per MIL-STD-883, Method 1005, 1000 Hrs. at +125 °C
MIL-PRF-38534, Group B Inspection
MIL-PRF-38534, Group C Inspection

5.0 Preservation, Packaging and Packing: The oscillators shall be clean, dry and packaged in a manner to provide adequate protection against electrostatic discharge, corrosion, deterioration and physical damage during shipment.

6.0 Part Numbering Example:

FT1	-	50	N	/	V	/	100
		Overall frequency accuracy *	Pin 1 Connection		Screening Level		Frequency
		100 = 100 ppm over -40°C to +85°C	N = Not connected		N = No Screening		KHz/MHz
		050 = 50 ppm over -40°C to +85°C	E = Enable/Disable		I = Industrial Std		
		025 = 25 ppm over -40°C to +85°C			M = MIL-STD-883		
		010 = 100 ppm over -55°C to +125°C			B = MIL-PRF-55310D Class B		
		50 = 50 ppm over -55°C to +125°C			S = MIL-PRF-55310D Class S		
		20 = 20 ppm over -20°C to +70 °C			V = MIL-PRF-55310D Class S, 50krad(Si) total dose		
					R = MIL-PRF-55310D Class S, 100krad(Si) total dose		

* Overall Frequency Accuracy includes effects of Operating Temperature, Supply Voltage, Load variations and 10 year aging

P/N Example: FT150NV - 50.000 MHz = 50.000 MHz, Class "V" Oscillator, ± 50 PPM Overall Frequency Accuracy over an operating temperature range of -55 °C to +125 °C, 1.8V, Pin1-N/C

NOTE: Besides **Class R** and **Class V**, the following additional models are available for applications that can accommodate reduced level of screening and quality conformance inspection:

Class S : **Class S** is same as **Class R** and **Class V** except as follows:

Group A inspection is per MIL-PRF-55310, Class B

Group B inspection (30 day aging) per MIL-PRF-55310 is not applicable

Class B : **Class B** uses the same design and elements as **Class S** except as follows:

100% screening is as per Table III herein

PDA for Burn-in is 10% or 1 unit whichever is greater

Delta measurements of paragraph 4.3 are not applicable

Group A inspection is as per MIL-PRF-55310, Class B

Group B inspection (30 day aging) per MIL-PRF-55310 is not applicable

Class M : **Class M** is same as **Class B** except as follows:

Active and Passive Elements are as per MIL-PRF-55310, Class B. Microcircuit die

is similar to the one used in Model FTH4XXB but is not from radiation tested wafer lot.

Class I/N : **Class I** and **Class N** is a form, fit and function equivalent prototype of **Class R** to **Class M**

Prototypes may use and industrial and commercial grade elements and are not screened. Quality Conformance inspection is not applicable.



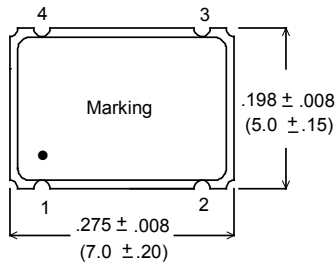

PAD#	FUNCTION
1	N/C or E/D
2	GND/CASE
3	OUTPUT
4	VDD

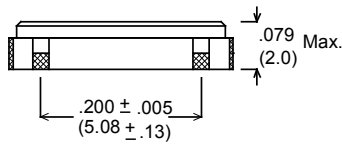

Dimensions: Inches (mm).

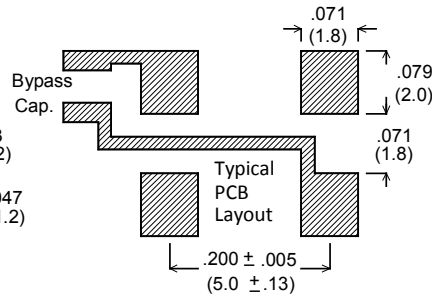
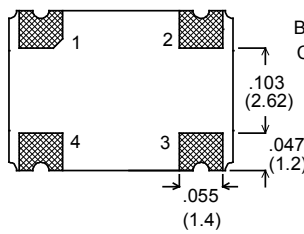

E/D (Enable/Disable) Input: A "Low" level at the input disables the Output into a high impedance state.

E/D Input has internal pull-up, it can be left floating or connected to Vdd.

An External 0.01uF Bypass Capacitor is required between VDD and GND.

Figure 1 - Package Configuration & Pin Connections

Test Circuit and Waveform

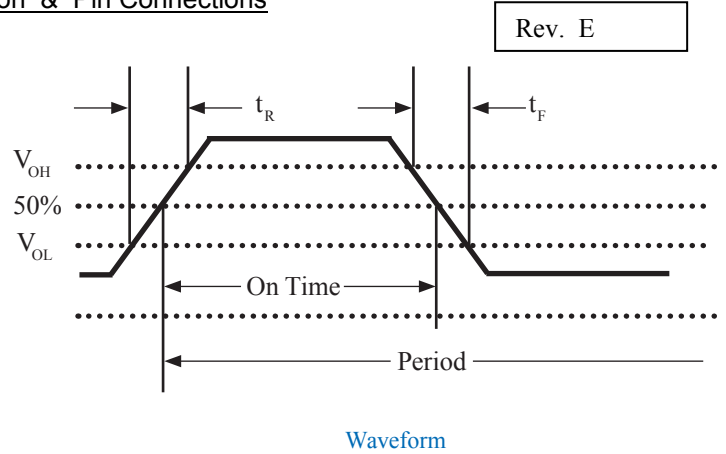
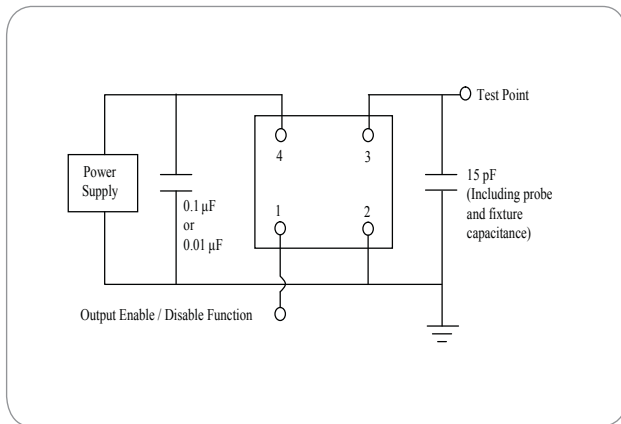

Waveform

Reflow Cycle (typical for lead free processing)

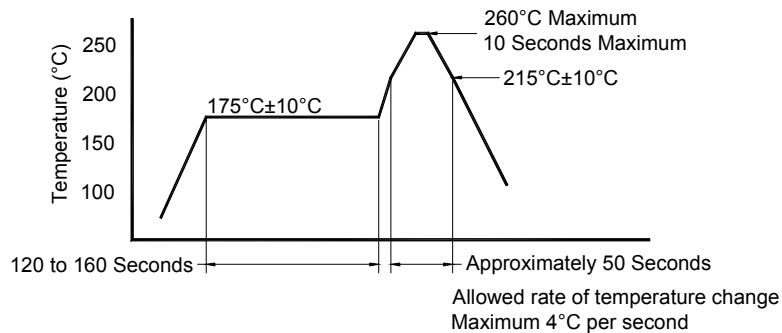

TABLE I – Electrical Characteristics

Parameter	Spec. Limits
Frequency Range	500 KHz to 180 MHz
Overall Frequency Accuracy ^{1/}	See Options in Paragraph 6.0
Operating Temperature Range	See Options in Paragraph 6.0
Input Voltage	+ 1.8 VDC \pm 5%
Input Current at 1.8V (no load) 500.00 KHz to 30.0 MHz 30.0 MHz to 70.0 MHz 70.0 MHz to 165.0 MHz	10mA Max. 15mA Max. 25mA Max.
Output Waveform	Square Wave, HCMOS/TTL
Output Duty Cycle	40/60% Max
Output Load	10K 15 pF
High Output Level	0.90 VDD Min
Low Output Level	0.10 VDD Max.
Rise & Fall Times \leq 40.00 MHz >40.00 MHz	6 nS Max. 5 nS Max.
Start-up Time	10 mS Max.
Phase Jitter	0.5 pS rms typ, (10 KHz to 20 MHz Integrated)
Frequency Aging @ 70 °C	1.5 PPM Max./30 days, 3 PPM / Year Max.

Contact Fre-tech Engineering for any other special requirements.

^{1/} Overall Frequency Accuracy includes calibration tolerance, frequency change due to Operating Temperature, Supply Voltage and Load variations and 10 year aging.



Table II - Class R/V/S , Screening (100%)

Test - Inspection	Test Method – Condition
Nondestructive Bond Pull	MIL-STD-883, Method 2023
Internal Visual	MIL-STD-883, Method 2017, Level S
Stabilization Bake (Prior to Seal) ^{1/}	MIL-STD-883, Method 1008, Condition C (+150 °C), 48 hours minimum
Thermal Shock	MIL-STD-883, Method 1011, Condition A
Temperature Cycling	MIL-STD-883, Method 1010, Condition B
Constant Acceleration	MIL-STD-883, Method 2001, Condition A Y ₁ axis only (5000 G)
Seal (Fine and Gross Leak)	MIL-PRF-55310, Para. 4.8.2.2.2
Particle Impact Noise Detection (PIND)	MIL-STD-883, Method 2020, Condition A
Radiographic Inspection	MIL-STD-883, Method 2012, Class S
Electrical Tests: Record all measurements. Input Current Output Frequency Output Voltage Levels Output Rise & Fall Times Output Duty Cycle	Nominal Supply Voltage, Specified load, +23 °C MIL-PRF-55310, Para. 4.8.5 MIL-PRF-55310, Para. 4.8.6 MIL-PRF-55310, Para. 4.8.21.3 MIL-PRF-55310, Para. 4.8.22 MIL-PRF-55310, Para. 4.8.23
Burn-in (load)	+125 °C, Nominal Supply Voltage and Burn-in load, 320 Hours Minimum
Electrical Tests: Record all measurements. Input Current Output Frequency Output Voltage Levels Output Rise & Fall Times Output Duty Cycle	Nominal and Extreme Supply Voltages, Specified load, +23 °C and operating temperature extremes, MIL-PRF-55310, Para. 4.8.5 MIL-PRF-55310, Para. 4.8.6 MIL-PRF-55310, Para. 4.8.21.3 MIL-PRF-55310, Para. 4.8.22 MIL-PRF-55310, Para. 4.8.23

^{1/} Vacuum bake and maintain oscillators in dry nitrogen per MIL-PRF-55310.



Table III - Class B/M Screening (100%)

Test - Inspection	Test Method – Condition
Nondestructive Bond Pull	MIL-STD-883, Method 2023
Internal Visual	MIL-STD-883, Method 2017, Level B
Stabilization Bake (Prior to Seal) ^{1/}	MIL-STD-883, Method 1008, Condition C (+150 °C), 24 hours minimum
Temperature Cycling	MIL-STD-883, Method 1010, Condition B
Constant Acceleration	MIL-STD-883, Method 2001, Condition A Y ₁ axis only (5000 G)
Seal (Fine and Gross Leak)	MIL-PRF-55310, Para. 4.8.2.2.2
Particle Impact Noise Detection (PIND)	MIL-STD-883, Method 2020, Condition A
Electrical Tests: Input Current Output Frequency Output Voltage Levels Output Rise & Fall Times Output Duty Cycle	Nominal Supply Voltage, Specified load, +23 °C Verify all parameters MIL-PRF-55310, Para. 4.8.5 MIL-PRF-55310, Para. 4.8.6 MIL-PRF-55310, Para. 4.8.21.3 MIL-PRF-55310, Para. 4.8.22 MIL-PRF-55310, Para. 4.8.23
Burn-in (load)	+125 °C, Nominal Supply Voltage and Burn-in load, 160 Hours Minimum
Electrical Tests: Input Current Output Frequency Output Voltage Levels Output Rise & Fall Times Output Duty Cycle	Nominal Supply Voltage, Specified load, +23 °C and verify frequency at temperature extremes. MIL-PRF-55310, Para. 4.8.5 MIL-PRF-55310, Para. 4.8.6 MIL-PRF-55310, Para. 4.8.21.3 MIL-PRF-55310, Para. 4.8.22 MIL-PRF-55310, Para. 4.8.23

^{1/} Vacuum bake and maintain oscillators in dry nitrogen per MIL-PRF-55310.

